

Description

The DVC200A100 DigiFlex® Performance™ digital servo drive is designed to drive brushed, brushless, and AC induction servomotors from a compact form factor ideal for embedded applications. This fully digital drive operates in torque, velocity, or position mode and employs Space Vector Modulation (SVM), which results in higher bus voltage utilization and reduced heat dissipation compared to traditional PWM.

DVC200A100 servo drives feature a single USB interface used for drive configuration and setup. Drive commissioning is accomplished using DriveWare® 7, available for download at www.a-m-c.com. The CANopen interface can be used for runtime operation in networked applications.

DVC200A100 servo drives are packaged in a ruggedized, watertight IP65 rated enclosure ideal for mobile electric vehicular applications. Multiple throttle input command types and configurations are available for selection within DriveWare® 7.

All drive and motor parameters are stored in non-volatile memory. The DVC Series Hardware Installation Manual is available for download at www.a-m-c.com.

Power Range

Peak Current	200 A (141.4 A _{RMS})
Continuous Current	125 A (125 A _{RMS})
Supply Voltage	20 - 80 VDC



Features

- ▲ Follows the CAN in Automation (CiA) 301 Communications Profile and 402 Device Profile
- ▲ Four Quadrant Regenerative Operation
- ▲ Space Vector Modulation (SVM) Technology
- ▲ Fully Digital State-of-the-art Design
- ▲ Programmable Gain Settings
- ▲ Fully Configurable Current, Voltage, Velocity and Position Limits
- ▲ Four Quadrant Regenerative Operation
- ▲ PIDF Velocity Loop
- ▲ PID + FF Position Loop
- ▲ On-the-Fly Mode Switching
- ▲ On-the-Fly Gain Set Switching
- ▲ Selectable 120/60 Hall Commutation Phasing
- ▲ Ingress Protection Rating: IP65
- ▲ Electromagnetic Holding Brake Output
- ▲ Dedicated Safe Torque Off (STO) Inputs

MODES OF OPERATION

- Profile Current
- Profile Velocity
- Profile Position
- Interpolated Position Mode (PVT)

COMMAND SOURCE

- ±10 V Analog
- Over the Network
- Vehicle Specific Commands
- Sequencing
- Indexing
- Jogging

FEEDBACK SUPPORTED

- ±10 VDC Position
- Halls
- Incremental Encoder
- Tachometer (±10 VDC)

INPUTS/OUTPUTS

- 2 Programmable High Powered Digital Outputs
- 2 Programmable Analog Inputs (12-bit Resolution)
- 4 Programmable Digital Inputs (Single-Ended)
- 2 Programmable Digital Outputs (Single-Ended)



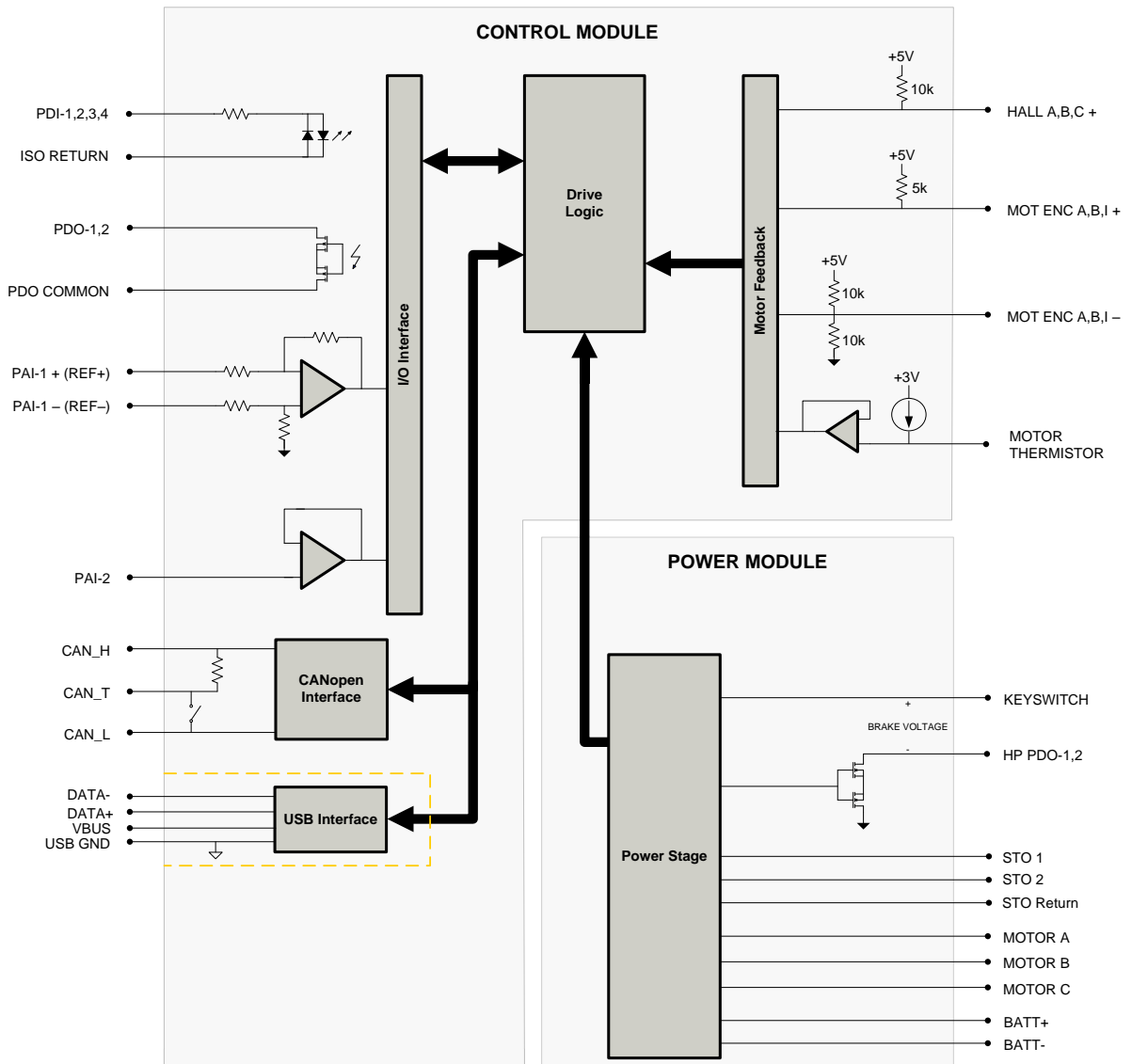

COMPLIANCES & AGENCY APPROVALS

- UL
- cUL
- CE Class A (LVD)
- CE Class A (EMC)
- RoHS
- TÜV Rheinland® (STO)

BLOCK DIAGRAM



Information on Approvals and Compliances

	<p>US and Canadian safety compliance with UL 508c, the industrial standard for power conversion electronics. UL registered under file number E140173. Note that machine components compliant with UL are considered UL registered as opposed to UL listed as would be the case for commercial products.</p>
	<p>Compliant with European EMC Directive 2004/108/EC on Electromagnetic Compatibility (specifically EN 61000-6-4:2007 for Emissions, Class A and EN 61000-6-2:2005 for Immunity, Performance Criteria A). LVD requirements of Directive 2006/95/EC (specifically, EN 60204-1:2004, a Low Voltage Directive to protect users from electrical shock).</p>
	<p>RoHS (Reduction of Hazardous Substances) is intended to prevent hazardous substances such as lead from being manufactured in electrical and electronic equipment.</p>
	<p>Functional Safety STO is TUV Rheinland® certified and meets requirements of the following standards:</p> <ul style="list-style-type: none"> • EN ISO 13849-1 Category 4 / PL e • EN IEC 61800-5-2 STO (SIL 3) • EN62061 SIL CL3 • IEC 61508 SIL 3

SPECIFICATIONS

Power Specifications		
Description	Units	Value
DC Supply Voltage Range	VDC	20 - 80
DC Bus Over Voltage Limit	VDC	92
DC Bus Under Voltage Limit	VDC	16
Logic Supply Voltage (Keyswitch)	VDC	20 - 80
Safe Torque Off Voltage	VDC	24 (±6)
Maximum Peak Output Current ¹	A (A _{RMS})	200 (141.4)
Maximum Continuous Output Current ²	A (A _{RMS})	125 (125)
Max. Continuous Output Power	W	9500
Max. Continuous Power Dissipation	W	500
Internal Bus Capacitance	µF	6000
Minimum Load Inductance (Line-To-Line) ³	µH	200
Switching Frequency	kHz	14
Maximum Output PWM Duty Cycle	%	85
Control Specifications		
Description	Units	Value
Command Sources	-	±10 V Analog, 0 – 5 V Analog, 0 – 5 kΩ, Over the Network, Sequencing, Indexing, Jogging
Feedback Supported	-	±10 VDC Position, Halls, Incremental Encoder, Tachometer (±10 VDC)
Commutation Methods	-	Sinusoidal, Trapezoidal
Modes of Operation	-	Profile Current, Profile Velocity, Profile Position, Interpolated Position Mode (PVT)
Motors Supported	-	Closed Loop Vector, Single Phase (Brushed, Voice Coil, Inductive Load), Three Phase (Brushless)
Hardware Protection	-	40+ Configurable Functions, Over Current, Over Temperature (Drive & Motor), Over Voltage, Short Circuit (Phase-Phase & Phase-Ground), Under Voltage
Programmable Digital Inputs/Outputs (PDIs/PDOs/HP PDOs)	-	4/2/2
Programmable Analog Inputs/Outputs (PAIs/PAOs)	-	2/0
Primary I/O Logic Level	-	24 VDC
Current Loop Sample Time	µs	71
Velocity Loop Sample Time	µs	143
Position Loop Sample Time	µs	143
Maximum Encoder Frequency	MHz	20 (5 pre-quadrature)
Mechanical Specifications		
Description	Units	Value
Agency Approvals	-	CE Class A (EMC), CE Class A (LVD), cUL, RoHS, UL, TUV Rheinland® (STO)
Size (H x W x D)	mm (in)	203.2 x 139.7 x 59.7 (8.0 x 5.5 x 2.4)
Size (H x W x D) with 35-pin mating connector installed	mm (in)	203.2 x 139.7 x 74.0 (8.0 x 5.5 x 2.9)
Weight	g (oz)	1638.60 (57.80)
Heatsink (Base) Temperature Range ⁴	°C (°F)	0 - 75 (32 - 167)
Storage Temperature Range	°C (°F)	-20 - 85 (-4 - 185)
Cooling System ³	-	Natural Convection
Form Factor	-	Vehicle Mount
IP Rating	-	65
I/O Connector	-	35-pin, AMPSEAL connector
AUX COMM Connector	-	5-pin, Mini USB B Type port
MOTOR POWER Connector	-	3 Individual M6 threaded terminals
POWER Connector	-	2 Individual M6 threaded terminals

Notes

1. Maximum duration of peak current is ~10 seconds for zero-to-peak current commands.
2. Continuous A_{RMS} value attainable when RMS Charge-Based Limiting is used.
3. Lower inductance is acceptable for bus voltages well below maximum. Use external inductance to meet requirements.
4. Additional cooling and/or heatsink is required to achieve rated performance. Thermal grease recommended between baseplate and external heatsink.

Mating Connector Kit

Mating connector housing, socket contacts, and seal plugs can be ordered as a kit using *ADVANCED* Motion Controls' part number **KC-35AMPSEAL01**.

PIN FUNCTIONS

I/O - Signal Connector			
Pin	Name	Description / Notes	I/O
1	HP PDO-1	High Powered Programmable Digital Output (Digital Output 3 in DriveWare)	O
2	PDI COMMON	Digital Inputs Ground	PDIGND
3	PDI-1	Programmable Digital Input	I
4	PDO COMMON	Digital Outputs Ground	PDOGND
5	STORET	Safe Torque Off Return	STORET
6	PAI-2	Programmable Analog Input (12-bit Resolution)	I
7	PAI COMMON	Analog Inputs Ground	PGND
8	CAN_T	CAN Termination. Connect to CAN_L (Pin 19) if drive is the last device on the CAN network, or use DIP Switch #7 – see Hardware Settings for switch description.	I/O
9	MOT ENC A+	Differential Encoder A Channel Input (For Single Ended Signals Use Only Positive Input)	I
10	MOT ENC B+	Differential Encoder B Channel Input (For Single Ended Signals Use Only Positive Input)	I
11	MOT ENC I+	Differential Encoder Index Input (For Single Ended Signals Use Only Positive Input)	I
12	+5V OUT	+5V 250mA Encoder and Hall Supply Output (Short Circuit Protected)	O
13	HP PDO-2	High Powered Programmable Digital Output (Digital Output 4 in DriveWare)	O
14	PDI-2	Programmable Digital Input	I
15	PDO-1	Programmable Digital Output	O
16	STO-1	Safe Torque Off – Input 1.	I
17	POT HIGH	+5V @ 5 mA output supply. For external 5k potentiometer command. Reference to pin 7.	O
18	PAI-1- (REF-)	Differential Programmable Analog Input or Reference Signal Input (12-bit Resolution)	I
19	CAN_L	CAN_L Line (Dominant Low)	I
20	MOT ENC A-	Differential Encoder A Channel Input (For Single Ended Signals Use Only Positive Input)	I
21	MOT ENC B-	Differential Encoder B Channel Input (For Single Ended Signals Use Only Positive Input)	I
22	MOT ENC I-	Differential Encoder Index Input (For Single Ended Signals Use Only Positive Input)	I
23	FEEDBACK COMMON	Motor Feedback Ground	PGND
24	KEYSWITCH	Master switch for the drive. Logic power input supply. Voltage range equal to DC Supply Voltage Range (see specifications table). This must be ON for the drive to function. Reference to Power Ground.	I
25	PDI-3	Programmable Digital Input	I
26	PDI-4	Programmable Digital Input	I
27	PDO-2	Programmable Digital Output	O
28	STO-2	Safe Torque Off – Input 2	I
29	PAI-1+ (REF+)	Differential Programmable Analog Input or Reference Signal Input (12-bit Resolution)	I
30	CAN_GND	CANopen Ground	PGND
31	CAN_H	CAN_H Line (Dominant High)	I
32	HALL 1	Commutation Sensor Inputs	I
33	HALL 2		I
34	HALL 3		I
35	MOTOR THERMISTOR	Motor Thermistor Connection.	I

AUX. COMM - USB Communication Connector			
Pin	Name	Description / Notes	I/O
1	VBUS	Supply Voltage	O
2	DATA -	Data -	I/O
3	DATA +	Data +	I/O
4	RESERVED	-	-
5	USB GND	USB Ground	UGND

MOTOR POWER - Power Connector			
Terminal	Name	Description / Notes	I/O
MA	MOTOR A	Motor Phase A	O
MB	MOTOR B	Motor Phase B	O
MC	MOTOR C	Motor Phase C	O

POWER - Power Connector			
Terminal	Name	Description / Notes	I/O
B-	BATT - / POWER GROUND	Power Ground	PGND
B+	BATT +	DC Power Input. Battery Power.	I

I/O FEATURES

Programmable Analog Inputs

The Programmable Analog Inputs have voltage ranges of 0 to +5V for PAI-2 and -10 to +10V for PAI-1.

Function	Description / Notes
Command Inputs	Vehicle Throttle Command Interfaces may be configured for Wigwag or Inverse Wigwag through the setup software. <ul style="list-style-type: none">• 3-wire 5k Potentiometer Command• 5V Voltage Command

Programmable Digital Inputs

The Programmable Digital Inputs are +24VDC sinking or sourcing single-ended inputs.

Programmable Digital Outputs

The Programmable Digital Outputs are +24VDC sinking single-ended outputs. These can be used for standard fault output signals or used to sink an external LED.

Safe Torque Off (STO) Inputs

The Safe Torque Off (STO) Inputs are dedicated +24VDC sinking single-ended inputs. Both STO1 and STO2 must be active (HIGH) to allow torque output at the motor outputs.

High Powered Programmable Digital Outputs

The High Powered Programmable Digital Outputs are DIP Switch selectable for 24, 36, 48, or 72 V and sink up to 3A. A user-supplied load can be connected between the external Keyswitch supply and the HPDO. See Hardware Settings section for DIP Switch functionality. Examples of possible uses are given below.

Function	Description / Notes
Electromagnetic Holding Brake	When activated, the HPDO will energize an external user-supplied holding brake and release the motor. Electromagnetic holding brake is normally engaged to lock the motor shaft and keep the rotor from turning when the vehicle is stopped.
Main Contactor	When activated, the HPDO will engage the external user-supplied main power contactor to connect DC Bus power from the battery to the drive.

HARDWARE SETTINGS

Switch Functions

DIP Switches are located under the drive access panel. DIP Switch changes take effect after power cycling the drive.

Switch	Description	Setting	
		On	Off
1	Bit 0 of binary CANopen node ID.	1	0
2	Bit 1 of binary CANopen node ID.	1	0
3	Bit 2 of binary CANopen node ID.	1	0
4	Bit 3 of binary CANopen node ID.	1	0
5	Bit 4 of binary CANopen node ID.	1	0
6	Bit 5 of binary CANopen node ID.	1	0
7	CAN Termination. Internally connects 120 ohm resistor between CAN_H and CAN_L. Set to ON if drive is the last device on the network.	Terminating Node	Non-Terminating Node
8	HPDO Voltage Selection. See HPDO Voltage Selection Table below for DIP Switch Settings.	-	-
9		-	-
10		-	-

HPDO Voltage Selection Table

HPDO Voltage	SW8	SW9
24V	OFF	OFF
36V	ON	OFF
48V	OFF	ON
72V	ON	ON

CANopen Communication Bit Rate

The default CANopen bit rate is set in EEPROM at 1000 kbits/sec.

MECHANICAL INFORMATION

I/O - Signal Connector

Connector Information		35-pin, AMPSEAL connector
Mating Connector	Details	TE Connectivity: Housing P/N 776164-1; Socket Contacts P/N 770854-3 (loose); Seal Plug P/N 770678-1; Crimp Tool P/N 58529-1
	Included with Drive	No

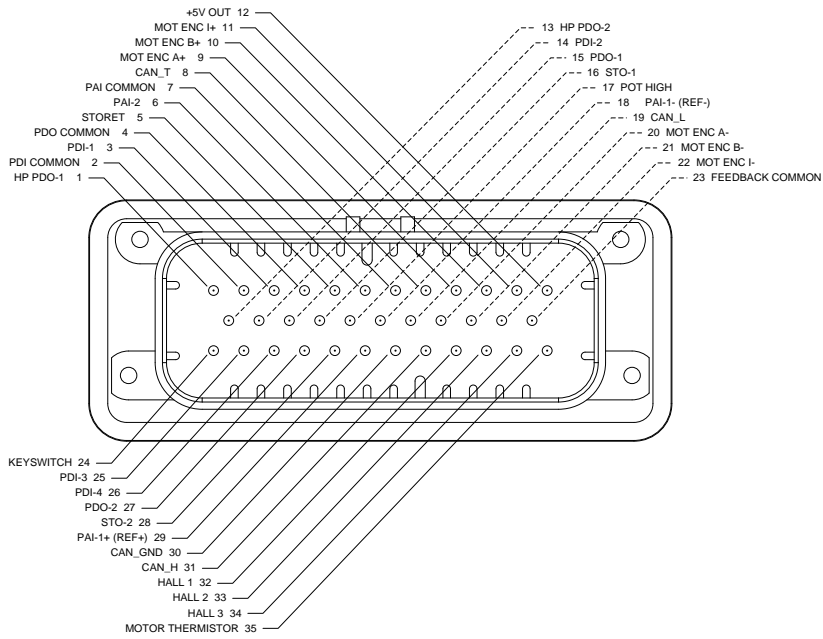

AUX. COMM – USB Communication Connector

Connector Information		5-pin, Mini USB B Type port
Suggested Mating Cable	Details	TYCO: 1496476-3 (2-meter STD-A to MINI-B ASSY)
	Included with Drive	No

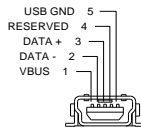

MOTOR POWER - Power Connector

Connector Information		Three individual M6 threaded terminals
Mating Connector	Details	M6 screw or bolt with washer
	Included with Drive	Yes

POWER - Power Connector

Connector Information		Two individual M6 threaded terminals
Mating Connector	Details	M6 screw or bolt with washer
	Included with Drive	Yes

MOUNTING DIMENSIONS

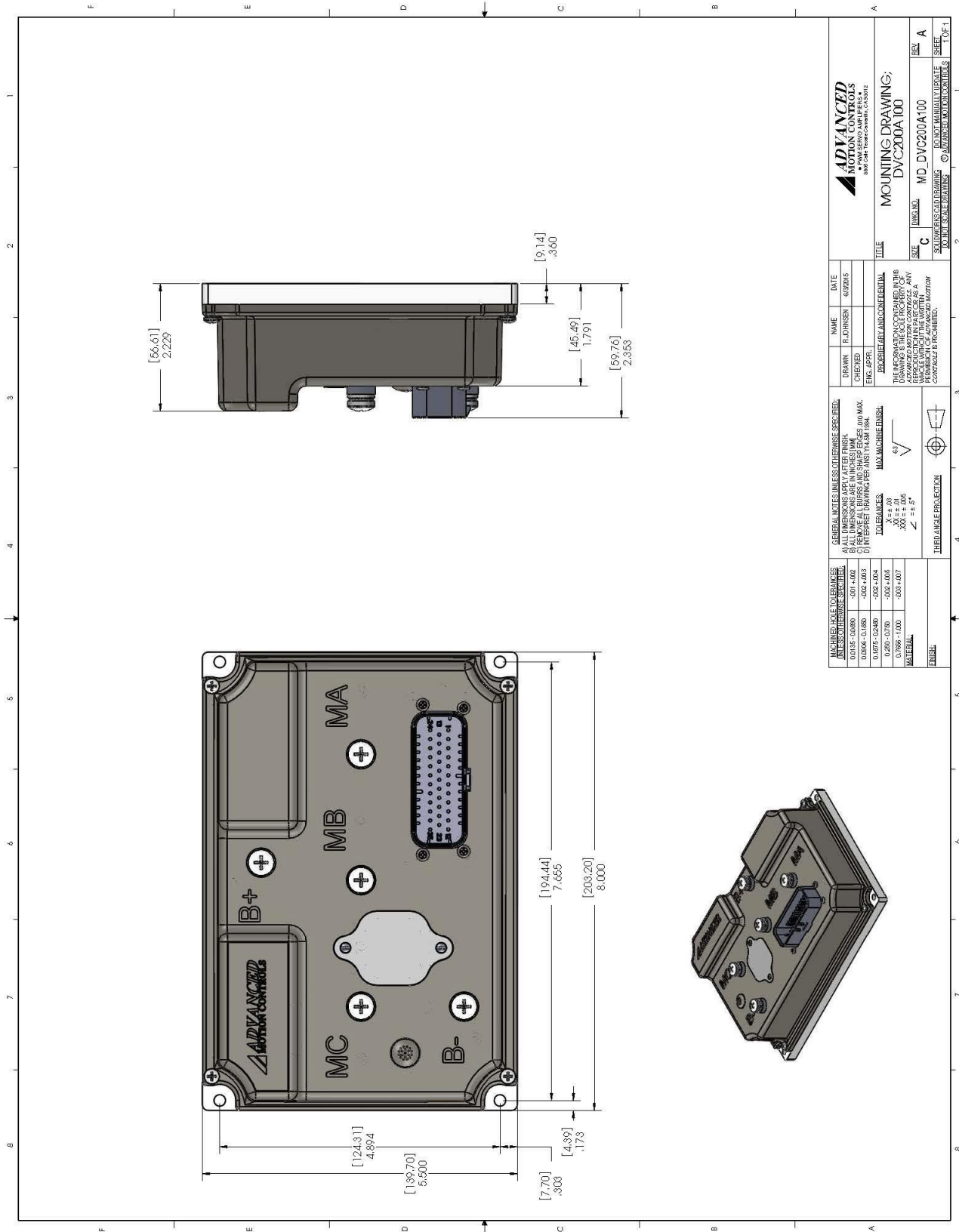

MACHINE TOLEANCES		NAME		DATE	
0.015-0.080	.001 +.002	DRAWN	B. JOHNSON	REVISED	
0.080-0.180	.002 +.003	CHECKED			
0.180-0.240	.002 +.004	ENG. APPR.			
0.250-0.750	.002 +.005				
0.750-1.000	.003 +.007				
TOLERANCES		PROPERTY AND CONFIDENTIAL			
MAX. MACHINE FINISH		THE INFORMATION CONTAINED IN THIS DRAWING IS THE SOLE PROPERTY OF ADVANCED MOTION CONTROLS. ANY REPRODUCTION IN PART OR IN WHOLE WITHOUT THE WRITTEN PERMISSION OF ADVANCED MOTION CONTROLS IS PROHIBITED.			
MATERIAL		TITLE			
FINISH		MOUNTING DRAWING; DVC200A100			
		SIZE			
		C			
		SHEET NO.			
		1			
		TOTAL SHEETS			
		1			
		REV. A			
		SHEET			
		TOP-1			

PART NUMBERING INFORMATION

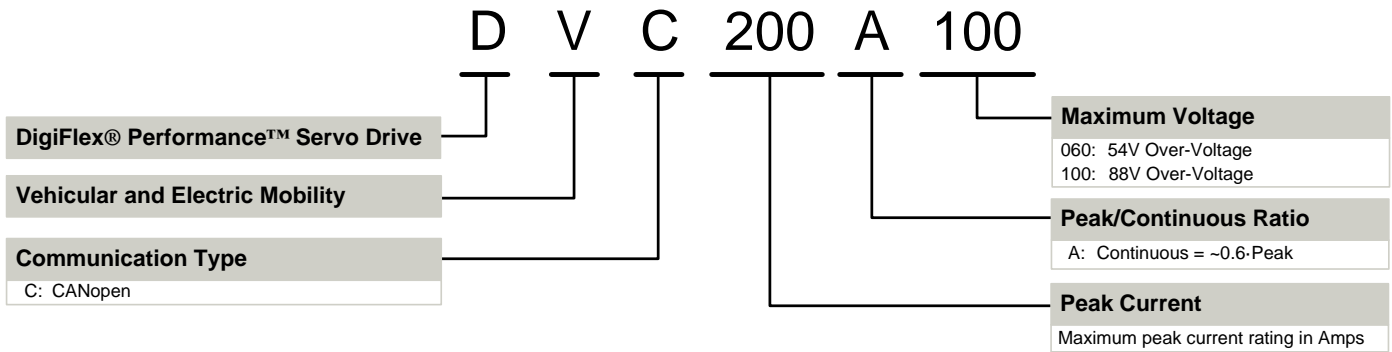

ADVANCED Motion Controls servo drives are available in many configurations. Note that not all possible part number combinations are offered as standard drives. All models listed in the selection tables of the website are readily available, standard product offerings.

ADVANCED Motion Controls also has the capability to promptly develop and deliver specified products for OEMs with volume requests. Our Applications and Engineering Departments will work closely with your design team through all stages of development in order to provide the best servo drive solution for your system. Equipped with on-site manufacturing for quick-turn customs capabilities, ADVANCED Motion Controls utilizes our years of engineering and manufacturing expertise to decrease your costs and time-to-market while increasing system quality and reliability.

Examples of Customized Products

- ▲ Integration of Drive into Motor Housing
- ▲ Mount OEM PCB onto Drive Without Cables
- ▲ Multi-axis Configuration for Compact System
- ▲ Custom PCB and Baseplate for Optimized Footprint
- ▲ RTV/Epoxy Components for High Vibration
- ▲ OEM Specified Connectors for Instant Compatibility
- ▲ OEM Specified Silkscreen for Custom Appearance
- ▲ Increased Thermal Limits for High Temp. Operation
- ▲ Integrate OEM Circuitry onto Drive PCB
- ▲ Custom Control Loop Tuned to Motor Characteristics
- ▲ Custom I/O Interface for System Compatibility
- ▲ Preset Switches and Pots to Reduce User Setup
- ▲ Optimized Switching Frequency
- ▲ Ramped Velocity Command for Smooth Acceleration
- ▲ Remove Unused Features to Reduce OEM Cost
- ▲ Application Specific Current and Voltage Limits

Feel free to contact Applications Engineering for further information and details.

All specifications in this document are subject to change without written notice. Actual product may differ from pictures provided in this document.